

GETTING STARTED IN RELOADING

In view of your present interest in the reloading subject, it is safe to assume that you have already had considerable shooting experience. Certainly, you have purchased, and fired, a good many rounds of factory loaded ammunition. Hence you are equipped with a working knowledge of the various caliber designations and cartridge shapes, and you recognize the correct cartridge for your particular gun. Probably many readers will have an overall understanding of shooting that extends beyond these simple basics. However, for the benefit of the uninitiated, we'll begin at this point.

Each factory loaded cartridge we purchase and fire represents extensive thought and care on the part of its manufacturer. If we are to reload a fired cartridge and duplicate, if possible, the original factory loading, we must first learn to appreciate some of the intricacies of ammunition design. For instance, the fired cartridge case is the most important reloading component.

Equipment Selection

You'll need to equip a reloading bench. While there are much less sophisticated reloading systems on the market, starting with the best gear you can afford quickly pays for itself by turning out excellent reloads on a volume basis.

We've listed our thoughts on basic equipment below and, for reloaders needing complete sets of matched equipment, Lyman now provides reloading kits which contain all needed items.

Equipment List:

- Reloading Press
- Shell Holder*
- Priming Arm
- Reloading Die Set*
- Scale
- Powder Measure
- Powder Funnel
- Case Lubricant with Pad
- Case Trimmer
- Deburring Tool
- Vernier Caliper or Case Length Gauge*
- Reloading Data
- Primer Tray

Optional Equipment:

- Automatic Primer Feed
- Case Neck Brush
- Inside Neck Reamers**
- Outside Neck Turner*
- Drop Tube Funnel
- Primer Pocket Cleaner*
- Primer Pocket Reamer*
- Powder Dribbler*
- Bullet Puller*
- Loading Block

*Not included in Expert Kit.

**Not available from Lyman.



**Lyman's Complete
Expert Reloading Kit**

CARTRIDGE CASES

The chief function of a cartridge case is to seal off the breech at the time of firing. To accomplish this, the case walls must expand freely so that they are tight against the sides of the chamber. This sealing action prevents the hot powder gases from leaking back around the cartridge and out through the action. Along with this, the cartridge case must withstand the chamber pressure built up during firing. To achieve this, the case requires a structural strength of its own - plus the additional supporting strength supplied by the bolt face and chamber wall. In essence, the case functions as an intrinsic part of the gun. **A gun is no stronger than the case that is used in it - nor is the case stronger than the gun.**

Cartridge brass is carefully tempered in its final manufacture. The head of the case is thick and tough which gives it the strength and rigidity necessary to resist the force of the chamber pressure. The forward section of the case (neck, shoulder and body) is considerably thinner than the head section. In manufacture, these portions are given an anneal which leaves them soft and ductile. The obvious advantage is that the case walls and neck will now expand freely to release the bullet and seal the chamber while the cartridge is fired.

As shooters, we may have been rather casual in our regard for empty brass cases, but as reloaders we soon come to think differently. Without a quantity of strong and serviceable cases, we would not get far in reloading ammunition. The most usual way for a reloader to



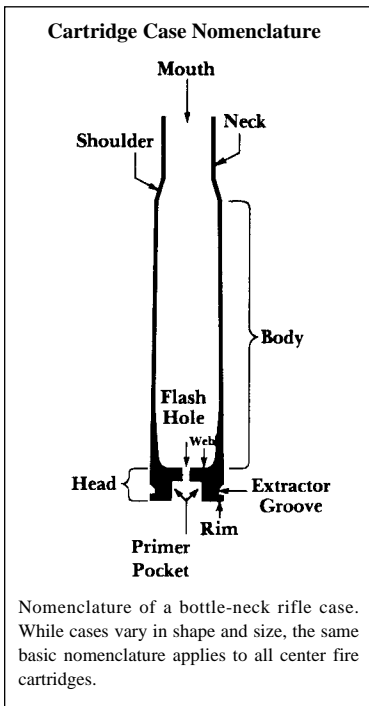

obtain serviceable cases is to purchase factory loaded ammunition. After this "store bought" ammo has been fired, the empty cases are retained for reloading. The reloader may also purchase new cases from his component dealer.

To make sure your cases are in prime condition, start with either new or once fired cases. Never use brass of unknown origin such as that found on a shooting range.

Each firing and resizing has an influence on the serviceability of the case. The battering of chamber pressure and the forces applied by the resizing die eventually work-harden the forward portion of the case and destroy its usefulness.

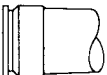

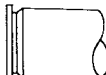
Case Styles

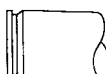
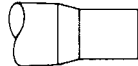
Rimmed			Belted			Straight**	
Semi-Rimmed			Reduced Head*			Straight Taper	
Rimless						Bottle-Neck	

* Function is basically the same as Rimless Type.
 ** Straight walled cases have a slight taper which is not visibly apparent.

This illustration shows the head forms and body shapes standard to cartridge design. Case examples for almost any combination of the above shapes may be encountered. For example: the 30/30 uses the rimmed bottle-neck, the 30/06 uses the rimless bottle-neck, the .458 Winchester uses the belted head and the straight body.

Carefully inspect your cases before each reloading. If your cases are new, or once fired, they will not reveal fatigue at the first reloading. However, fatigue signs will show up in subsequent loading, so you must learn to look for them. **Check your cases for splits or cracks in the neck, shoulder or body.** Reject all cases that show signs of defects, but flatten them with a pair of pliers before discarding to prevent their reuse. We suggest you separate your cartridge cases into lots and keep a record of their history.

Trimming is necessary when your cases have lengthened after numerous firings. Check your cases after resizing and never allow them to exceed the maximum listed measurement. How often you will need to trim the cases depends largely on the type of case you are using and the pressure of the load. Bottle-neck cases take more abuse from pressure than straight-sided cases and require trimming more often. The trimming of any case more than four times is not recommended. After this amount of trimming, it may be assumed that the case walls are now too thin, and the case should be discarded.

Case Diagnosis:



The condition pictured here illustrates case fatigue. Note how the cracks run lengthwise. Sometimes only pin hole cracks are noticeable, but such cases must also be discarded. Pistol cases show similar cracks.

Condition "A"
Case Fatigue

Case Diagnosis (continued)



**Condition “B” Excessive
Headspace**

The condition pictured in this example is quite different from case fatigue. This crack runs around the circumference of the case and indicates an excessive headspace condition. Never use any rifle which shows signs of excessive headspace.

To properly check the length of your cases, you will need a good vernier caliper available at most hardware stores.

In addition, the reloader needs an accurate means of case trimming. The Lyman Universal Trimmer is actually a miniature lathe featuring a unique chuck head which accepts all metallic cartridge cases, rifle or pistol. The tool is supplied with complete instructions and does the trimming operation quickly and easily.

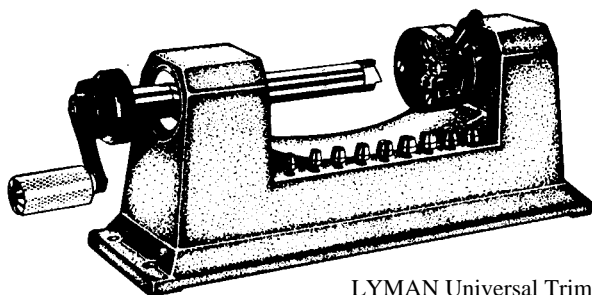

LYMAN Universal Trimmer

When loading new or once-fired cases, it is necessary to remove the sharp inside edges of the case mouth. This operation is called **chamfering** and its purpose is to ease insertion of the new bullet. **Chamfering** is required only for the first reloading of a new or once-fired case. The inexpensive hand reamer which is available at most dealers chamfers a case easily and uniformly. Hold the case in one hand while you lightly turn the reamer in the case mouth with the other hand. Remove very little material and do not cut a sharp knife edge on the case.

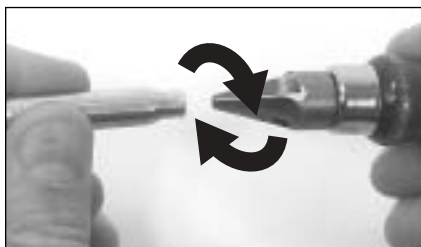

When chamfering turn the reamer lightly, removing very little case material.

CASE CLEANING

Reloaders should clean their cartridge cases twice in the process of reloading them. The first time is after firing and before resizing. The second time is after resizing but before firing the completed reload. Here's why.

When a cartridge is fired, the process of combustion always leaves a bit of residue on the walls of the chamber as well as on the inside and outside of the brass cartridge case. The amount of residue - or fouling - will vary with the type of propellant and intensity of the load. Often, spent cases which held light loads will be dirtier than those loaded to maximum. The reason is that the reduced loading did not expand the cartridge case enough to effect a complete gas seal.

In any event, the fired cartridge case is both dirty and tarnished and should be cleaned before reloaded. Cases which go, uncleaned, from reloading to reloading will quickly become scratched and may well cause permanent scratches to develop in the highly polished walls of your expensive resizing die.

The cartridge case will need cleaning one more time during the process of reloading; before the finished cartridge is fired. This cleaning removes resizing lubricant applied to the case before the resizing operation. The only exception to this second cleaning operation would be those pistol cases resized in a tungsten carbide die. No lube is required, because of the super-slick T/C ring, so there is none to be removed.

Reloaded cartridges which do not have the resizing lubricant removed will generate increased thrust on the breech/bolt face of your gun. This might cause malfunctions or, in extreme cases, damage your gun.

At best, shooting these uncleaned slippery cases is bad reloading practice because the case and chamber are not allowed to interact properly. During the firing process the walls of the brass cartridge case are intended to expand as pressure quickly builds. This expansion is stopped by the walls of the gun's chamber and the case is pressed firmly against the chamber walls, gripping them and resisting the rearward thrust of chamber pressure. The presence of resizing lubricant on the cartridge denies the cartridge case its "grip" and causes an unusual amount of pressure to be transferred to the breech/bolt face.

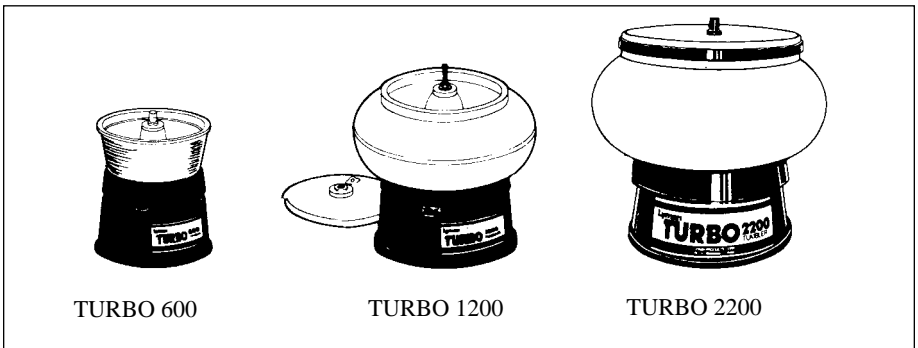

Case Cleaning (continued)

Removing Resizing Lubricant

Resizing lubricant can be removed by cleaning the cases with solvent, soapy hot water or tumbling in a suitable dry media.

If the cases are washed in hot soapy water, they must be rinsed and thoroughly dried before reloading. The drying process may be hastened by placing the wet cases on a cookie sheet and heating them in your oven, at about 200°F, for about two hours. The hot soapy water, followed by a hot water rinse, will remove both petroleum and wax-base lubricants.

Lubricants with a petroleum base may also be removed with a suitable solvent. One which evaporates quickly is best and proper ventilation is essential.

Finally, resizing lubricant of any sort may be removed by simply returning the cartridge cases to the standard media and tumbling them for another hour or two. The Lyman media will absorb the lubricant. This technique would shorten the life of your media somewhat - perhaps to an unnoticeable degree - and, with repeated cleansing of lubed cases, you would be faced with either reactivating or replacing your media charge a bit earlier.

The advantages of cleansing in the media are that there is no problem with fumes or extended drying periods. When the cases come out of the tumbler, they are ready for the final steps of reloading. Be sure to inspect all the primer pockets for bits of media clogging flash holes before you recap.

The best time to remove the resizing lubricant with your Lyman tumbler is after resizing/decapping and before recapping. If your cartridges are already loaded and ready to fire, the lubricant should be removed by hand using a rag wet with a suitable solvent. **Never tumble loaded rounds.**

POWDER

Many people are concerned with the dangers of handling and loading modern smokeless powders. To the uninitiated, gun powder is often regarded as “explosive” - something to be feared as much as dynamite. This is a natural but erroneous presumption.

The various modern powders used in reloading are classified as propellents, which means they are chemical mixtures designed to burn under controlled conditions, and to propel a shot charge or projectile. A high explosive, on the other hand, is a completely different breed of cat. These mixtures are quite dangerous because they are designed to detonate. When a substance such as dynamite or blasting gelatin is detonated, it produces intense heat and violent shock waves. These shock waves exert tremendous pressure on anything they contact, which makes it almost impossible to vent away the effects of detonation involving any appreciable quantity of explosive material.

While not to be compared to explosives, modern reloading powders are nonetheless highly flammable. They not only burn, they burn vigorously. In case of accidental ignition, a great amount of high temperature gas will be formed. If the powder is stored in its original factory canister, as it should be, this gas will create a pressure on the relatively fragile sides of the can. The pressure will split open the seams of the container, or pop off the lid. In such an event, the pressure remains at a low level if sufficient space is provided to accommodate the

Powder (continued)

escaping gas and vent it away.

For safe reloading, large quantities of reloading powder should never be stockpiled. The few cans that you do store must be handled with the care and caution due a flammable substance. In this way you control the situation so that it cannot get out of hand. Even in the case of a total house fire arising from other sources, smokeless powders will not produce the effect of an explosion if the proper precautions have been taken.

The burning characteristics of smokeless powders are complex in nature and, depending on the application of the powder, their burning rate can change drastically. While the chemical composition of a powder, the shape and size of its particles and the density or porosity of the powder composition tend to control burning rate, the application of each powder must be carefully considered. Other conditions such as the degree of confinement, heat of ignition, temperature of the combustion chamber, chamber pressure and the density of loading all affect the burning rate, yet such vital factors cannot possibly be included in the so-called burning rate charts.

All reloading powders are manufactured to an exacting set of specifications. They are sold in factory-sealed canisters with the name, or number, of each specific powder clearly printed on the label. When you purchase a reloading powder, you can be sure of obtaining the exact powder specified, and that the contents of the can have not been tampered with.

When weighing a powder charge, you depend on the accuracy of your powder scale and, of course, care must be taken. Reloading scales, such as the Lyman M-500 or M-1000 Scale, are designed specifically for the weighing of powders. These scales have a guaranteed accuracy of one-tenth of a grain, which is more than adequate for the most demanding reloading requirement.

**Visit our complete Lyman website at
www.lymanproducts.com**

PRIMERS

NOTE: This chapter refers only to rifle and pistol cartridge primers. For information pertaining to shotshell, see the current edition of the Lyman SHOTSHELL HANDBOOK.

For a cartridge to function properly, the successful operation of each component is required. Primarily from a safety standpoint, we have stated that the cartridge case is the most important component. However, if a primer does not ignite, we will have a misfire and all of our concern for case inspection, powder selection, etc., will be for naught. Therefore, every component, including the primer, is critical to the performance of the load.

Actually, the primer is responsible for only a small percentage of the accuracy of a given load, but its burning characteristics will add or detract from the overall pressure. How much these burning characteristics affect pressure is relative. It depends primarily upon the application of a specific primer to a specific set of conditions. Generally, the primer's influence on pressure is minimal when compared to the possible effects of other conditions and components. This influence, however, is not so slight that it can be overlooked.

In testing metallic cartridges we have noted pressure variations (due to primer change) of approximately 2,000 C.U.P. Further testing could indicate still greater variation. The point is that while metallic cartridge primers do not seem to vary greatly, enough variation exists to require us to re-work a load when changing primer type or brand. The reloader should stick with the same brand and type of primer when working up and using a load. If he changes the primer brand or type, he must then go back to the "starting load" and begin again.

If you examine a "Boxer-Type" primer carefully, you will note that the anvil protrudes slightly beyond the end of the primer cup. This is not an oversight in manufacture! The anvil is supposed to protrude so that it will seat solidly against the bottom of the primer pocket and firmly resist the force of the firing pin blow. If the primer is seated incorrectly (leaving space between anvil and bottom of pocket) then the entire primer will move forward when struck by the firing pin. Such a condition retards the blow of the firing pin and causes inconsistent ignition.

When seating primers, make sure that the primer bottoms in the primer pocket. However, the primer should not be crushed. Normally, when a primer is seated correctly, it will be flush

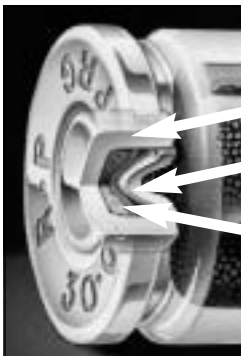

PRIMING CUP
ANVIL
PRIMING MIXTURE

Nomenclature of "Boxer-Type" Primer

The boxer type primer is used in all American metallic cartridges. The battery cup primer used in shotshells is of the same basic design, but contains an extra cup to facilitate its use in the less rigid shotshell case. The antique Berdan type primer functions in the same manner as the Boxer type, but with this primer the anvil is actually part of the case.

Primers (continued)

with the head of the case, or perhaps a few thousandths below. Be sure to check individual primer specifications. Under no circumstances should the primer stick out beyond the case head. Such a condition can prove dangerous, particularly in autoloading firearms, for the primer is in an exposed position. If such an improperly seated primer were to receive a blow from the bolt face, it could fire before the round was safely chambered.

Before seating a primer, examine it to make sure the anvil is not missing. Although this rarely occurs, the resultant misfire could be embarrassing if it should come at the wrong moment (such as when that trophy buck shows himself from behind the hemlocks).

Handling Primers

A word of caution on handling primers. Primers are detonated by percussion (a sharp blow). As packaged by the manufacturer, primers are quite safe, but they should not be tossed about or handled in a careless manner. Keep your primers in the factory container until they are to be used. Never store primers in a makeshift container. An old glass jar of primers could become lethal if dropped or accidentally knocked onto the floor.

Crimped Primers

Some military cases are loaded in a manner which employs a slight crimp over the primer to hold it snugly in place. These cases can be decapped without difficulty, but the crimp must be removed before the case can be primed again. Various commercial tools, which include the Lyman primer pocket reamer, are available to do this job. Primer pocket reamers come in two sizes, large and small.

One last thought - never decap live primers. If for some reason live ammunition must be disassembled, pull the bullet, pour out the powder, chamber the primed case in the firearm and snap the primer before decapping.

PROJECTILES

Never before have metallic cartridge reloaders had such an array of jacketed and cast bullets from which to choose. Until fairly recently most reloaders used jacketed bullets in their guns. That is still the case, but cast bullets are once again working their way back into the shooter's reloading repertoire.

Why?

Because properly made cast bullets can do many things the jacketed bullet can do. Reloaders, aware of the increasing cost of jacketed bullets, have found that cast bullets are good to use for recreational shooting - and even for hunting in .30 caliber and above. Besides, a cast bullet will cost approximately one-fifth as much as a corresponding jacketed bullet - and not a premium bullet, either!

There are several factors to consider when selecting a bullet besides having carefully tested load data for a given projectile weight:

1. Weight - For optimum potential accuracy the bullet must fall within a range peculiar to a given caliber. Also, the velocity at which that bullet will be driven is a factor. The whole idea is to properly blend the three (weight, rate of twist and velocity) to produce the results satisfying you, the reloader. Weight is important to the target shooters for its effect upon sectional density; hunters are concerned with weight for its implications to penetration potential on game.

Design Features of Cast Bullets

These four shapes are basic to cast bullet design. Actual bullets may vary to some extent, but, generally, they fall into one of these four categories.

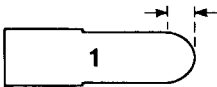

1
SHORT OGIIVE

(IDEAL DESIGNS) Bullets that conformed to either of these general shapes performed very well in our testing. Due to their short ogive, the greatest weight mass bears on some portion of the rifling. The driving bands bear directly on the groove, while the nose acts as a pilot to align the bullet in the throat and bore.

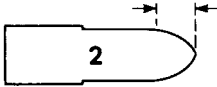

2
SHORT OGIIVE

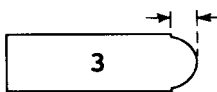

3
SHORT OGIIVE

(LOVERIN DESIGN) Bullets having this general shape performed extremely well in all of our testing. Due to their short ogive, the greatest weight mass bears directly on the groove. While the design does not always provide for a section of the bullet to bear on the lands, the many driving bands of groove diameter keep them well aligned.

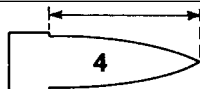

4
LONG OGIIVE

Bullets of this general shape proved to be the worst performers in our testing. Their long flowing ogives leave a portion of the bullet unsupported by the rifling. Cast bullets of this general shape can easily misalign themselves as they enter the throat and bore.

Projectiles (continued)

2. Base Design - There are two types: flat base and boattail. Of the two, the boattail has the most potential for accuracy in that the base can be more precisely made. Also, the boattail will produce less aerodynamic drag than will an otherwise identical projectile with a flat base. This means the boattail design will shoot flatter at extended range than will a flat base; all other variables being equal.

3. Point Design - There are various configurations within a given caliber ranging from aerodynamically sleek spitzer points for minimum drag to round noses particularly suited for short range hunting loads. These point shapes can also incorporate an exposed lead nose, hollow point or full coverage jacket.

The one firm rule for a cast bullet is that it must fit the bore of the gun in which it will be used. These lead alloy bullets, even the harder ones of Linotype or heat-treated wheelweights, are much easier to damage in firing than their jacketed descendants. They must fit precisely or they cannot perform at their best.

There is, even now, detectable variation in the bore and groove measurements of modern centerfire firearms. Cast bullets which do not fit properly are inaccurate and contribute to leading.

One last thing to remember about jacketed bullets is that the actual jacket material and projectile bearing surface will vary between manufacturers for bullets of identical weight and similar design.

**Visit our complete Lyman website at
www.lymanproducts.com**

MAKING CARTRIDGES

Now, if you have properly inspected your cases, selected a load, and purchased the necessary components (primers, powder and bullets), you are ready to begin. Your reloading press should be assembled and mounted according to the instructions supplied with the tool. Many reloading presses may be assembled to function either on the up-stroke or on the down-stroke of the handle.

First, lubricate your cases by wiping them with a cloth sparingly wet with Lyman Resizing Lubricant. Be frugal, for too much lubricant will trap air in the die and cause “lube dents”. Cases dented in this manner may be used for reloading, for the dent will be ironed out in firing. It is not considered good reloading practice, however, and care should be exercised.

Screw the Full-Length Resizing Die into the head of your press and adjust it according to the instructions supplied with the die.

Reloading Operations

There are only six basic mechanical operations required to reload a cartridge. Four of them are performed by the reloading dies. As you read through the text and take note of the illustrations, you will see how a set of only two reloading dies can accomplish all four of these operations.

1. Full-Length Resizing: When a cartridge is fired, the neck, shoulder and body of the case expand to seal the chamber, releasing the bullet. Since all chambers are not identical, cases fired in one rifle may not chamber in another unless their walls are reduced to a standard diameter that is acceptable to all rifles. This operation is called resizing.

2. Decapping: This operation consists simply of removing the old primer.

3. Inside Neck-Expanding: After a case has been resized, the inside diameter of its neck will be too small to accept the new bullet. Inside neck expanding enlarges the diameter of the neck to a size that will receive and hold the bullet securely. For pistol cases, a two-step expanding plug is used to open up the inside of the case neck. The first step on this plug is slightly smaller than bullet diameter, while the second step is a few thousandths larger. The idea behind this is to allow the bullet to enter the case freely without shaving lead. The actual difference between the two steps is not visually apparent.

4. Priming: This operation consists of inserting a new primer into the primer pocket.

5. Charging Powder: This operation consists of carefully weighing out and pouring the appropriate powder charge into the case.

6. Bullet Seating: The last operation in the reloading process is the seating of a bullet, into the case.

RELOADING THE BOTTLE-NECK RIFLE CASE

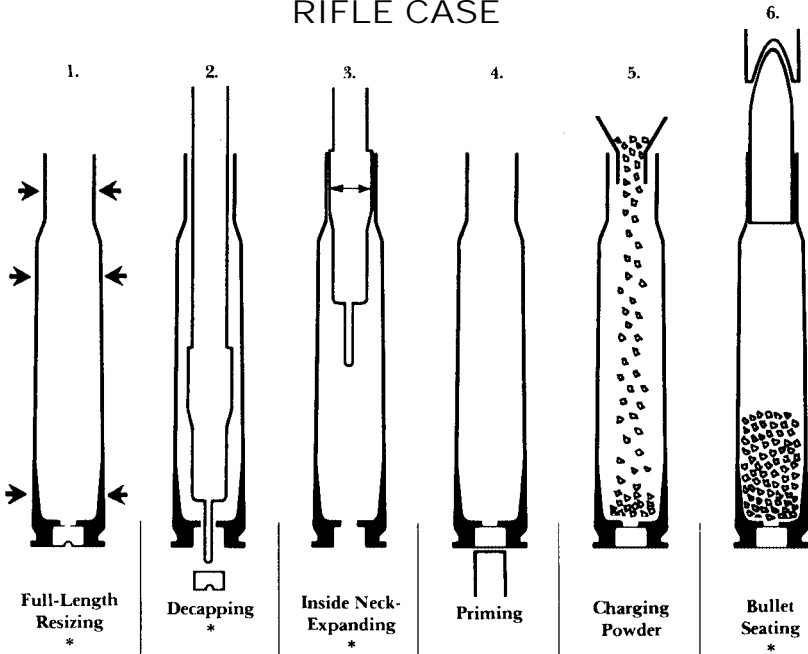

* Operations 1, 2, 3 and 6 are performed by reloading dies

RELOADING THE STRAIGHT-WALL PISTOL CASE

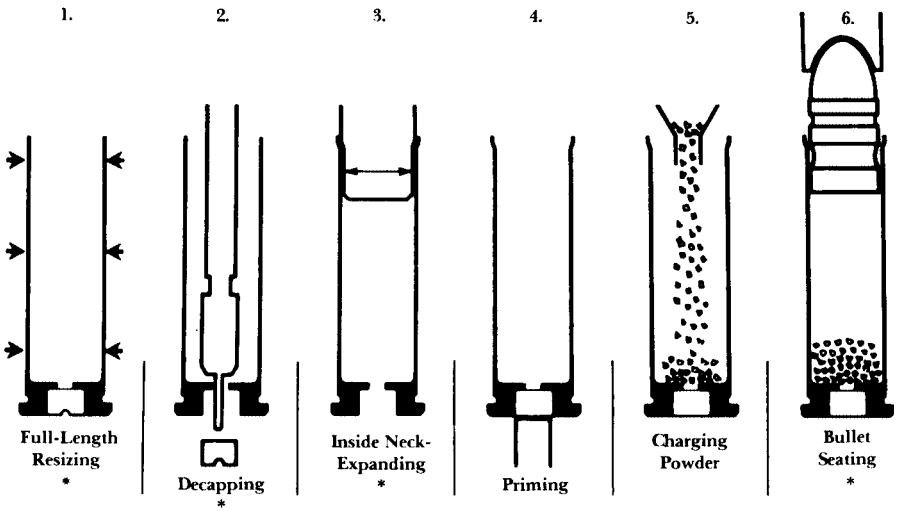

* Operations 1, 2, 3 and 6 are performed by reloading dies

RELOADING OPERATIONS

Step One (Full-Length Resizing and Decapping)

Slide the head of your cartridge case into the shell holder and pull the press handle down all the way. If the die is adjusted properly, the entire cartridge case will enter the die flush to the shell holder*. Note in the cut-away drawing how two of the original six reloading operations (full-length resizing and decapping) are accomplished by this step.

* See instructions supplied with your die set.

Step Two (Inside Neck-Expanding and Priming)

As your case is withdrawn from the resizing die, two further operations are done. The expanding button will automatically enlarge the neck, as shown in the cutaway drawing, and the priming punch will seat the new primer. As the expanding action of the button is automatic, you need not be concerned with it. You must, however, place the new primer (cup side up) into the priming punch sleeve. Push the priming arm forward (toward the press) and pull up on the press handle. As the ram is lowered, the priming arm will enter the slot in the side of the ram and seat the primer.

Seating Primers: Primers are seated mainly by feel. The bottom of the anvil **must bottom** in the primer pocket. Use care and do not crush the primer. Crushed primers give erratic ignition, or fail to fire.

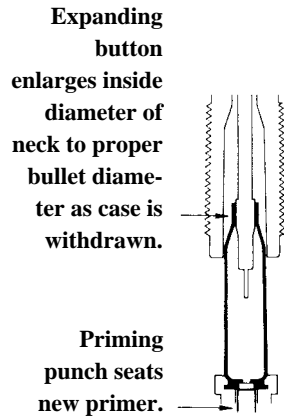
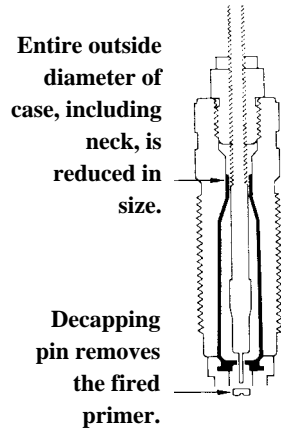

Visit our complete Lyman website at
www.lymanproducts.com

Reloading Operations (continued)

Step Three (Charging Powder)

You will need an accurate powder scale such as the Lyman M-500 or M-1000. The Reloading Handbook data section specifies the powders appropriate for your particular cartridge. It also lists a suggested weight of the powder charge in grains and in fractions of grains. For example, 9.5 grains would read as NINE and FIVE TENTHS grains. 10.0 grains would be read as TEN grains. We recommend the novice restrict himself to the suggested starting load. Carefully level the powder scale as explained in the scale instructions and set it to weigh your required charge.

Slowly sprinkle small amounts of powder into the scale pan until the beam comes into balance. The beam is in balance when the pointed end (extreme left) is exactly on the zero mark.

Carefully remove the pan and pour its contents into the cartridge case. Use a powder funnel to make sure all the powder enters the case. To avoid the possibility of accidentally "Double Charging" a cartridge, you should develop a foolproof system of loading. A suggested method is to place all the uncharged cases on your left. As you pick up each case for charging, turn it upside-down and shake it. This will insure that the case is empty. Turn the case right-side-up, charge it and place it carefully on your right. Take care when removing or replacing the scale pan that the poise are not accidentally moved.

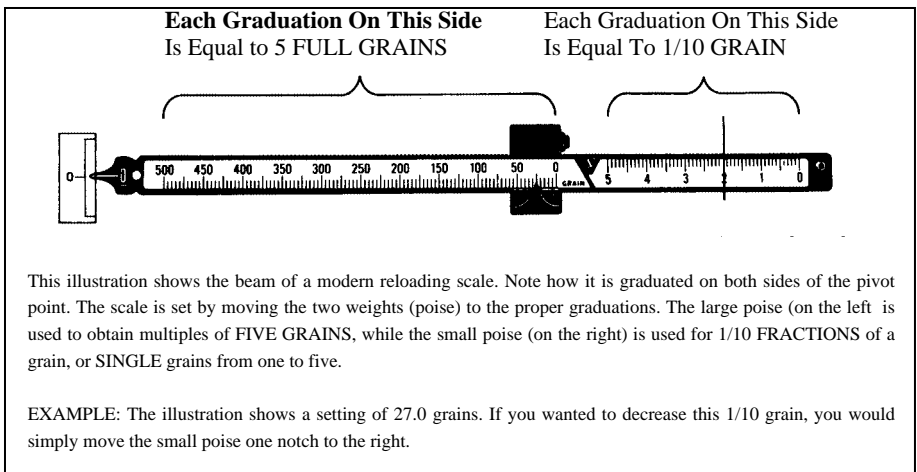

CAUTION: Technicians in the Lyman Lab have observed a potentially serious phenomena involving powder scales and plastic, loading blocks and/or Styrofoam packaging. It seems these substances sometimes retain a certain amount of static electricity, enough to create an electro-static field of varying radius.

This electro-static field has proven capable of radical deflection of uncharged and "zeroed" scales of all brands (available to us at the time). Of course, powder in the pan will tend to dampen the deflection but some still occurs depending on the charging level. Generally, the heavier the charge the less error ... assuming the scale was first "zeroed" correctly.

We suggest you clear the surface of your reloading bench and make very sure the scale is set up accurately. Then move your equipment back piece by piece, paying particular attention to the plastic or Styrofoam mentioned earlier. Please note this caution applies to all forms of reloading, not just metallic cartridges.

Step Four (Bullet Seating)

The last step in reloading a cartridge is seating the new bullet. Make certain that the overall length of the finished round is not longer than the maximum overall length listed in the data section of the Reloading Handbook.

This illustration shows how a bullet is seated. Screw the bullet seating die into the head of the press and adjust it according to the instructions supplied with the die. Place a primed, charged cartridge case in the shell holder and a bullet on the mouth of the case. Hold the bullet in place as you press the handle all the way down. As the case enters the die, the bullet will be pushed firmly into the neck of the case. Adjusting the seating screw controls the depth to which the bullet is seated. Adjusting the die body controls the crimp.

Crimping is a matter of choice and the seating die may be adjusted to crimp, or not to crimp, as you desire. If you are preparing hunting loads that will see hard usage in the magazine, it is wise to crimp-in the bullet. This prevents the bullets from unseating when the rifle is under recoil. Best accuracy, however, is usually obtained by not crimping-in the bullet. Target, or varmint loads, are best left uncrimped.

Built-in crimp shoulder affords crimping-in of bullets when desired. Do not crimp on jacketed bullets unless they have a crimping groove.

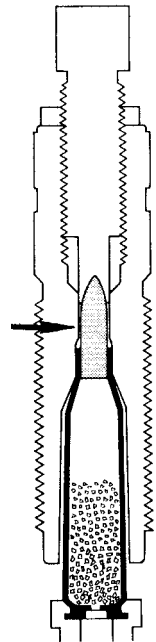

GETTING STARTED IN CASTING

Making the move into bullet casting is rather easy and not all that expensive considering that you'll be deriving additional enjoyment of your hobby - plus increased per-shot economy which quickly defrays equipment cost. If you are a muzzleloader, your start-up costs will be greatly reduced by the elimination of sizing and lubricating equipment.

The key to an easy introduction is starting out with the proper equipment. We feel that the beginning caster needs the following basic casting equipment to obtain good initial results: mould and handles, melting pot, pouring ladle, casting mallet, ingot mould and a lubricator/sizer fitted with appropriate top punch and sizing die. Muzzleloaders excused on the last item, as noted.

1. We feel our mould and handles offer the best investment to bullet casters. It is quite common to hear of Ideal/Lyman moulds which have been going strong for years. Some of our competitors offer less expensive moulds, but consideration of their rather short service life makes their purchase a questionable economy.

2. The melting pot is an item on which you can economize if you wish. Lyman offers two electric casting furnaces. These include the 20 pound capacity Mag 20 and the 8 pound capacity Mini-Mag Furnace. Also offered is a simple pot, holding about 8 pounds of alloy which

Casting Bullets (continued)

can be used on the kitchen stove or a camp stove out back or in the garage.

The mobility and versatility of the small pot can be a real blessing. The Lyman electric pots offer a great deal more capacity and sophistication. A major feature of the Mag 20 is the option of dipping bullet metal with a ladle or valve system. Additionally, the thermostat on this pot is calibrated with the scale on the control dial, permitting temperature settings to be noted for future use.

The Mag 20 is equipped with a "mould guide." This device is attached to the furnace legs and serves to align and support mould blocks while casting from the bottom pour valve.

If you are using the kitchen stove, exercise caution to avoid contaminating food and utensils with lead spatters or dust.

3. The pouring ladle, or dipper, is a good inexpensive buy. These are offered by several firms including Lyman. You should have one of these even if you buy one of the bottom-pour electric furnaces. Put ten bullet casters in a room, return in an hour, and you'll find two distinct groups: one in favor of bottom-pour; the other praising the dipper.

4. A casting mallet of some sort is needed with which to strike the mould's sprue plate to cut off the bullet's sprue. A hammer handle will do, as will a number of other implements which have non-marring faces. You cannot use any object which will mar or dent the mould.

5. The ingot mould, like the dipper and iron pot, should be a basic item in your initial investment. This mould allows you to empty your pot or furnace at the end of a casting session and produce easily-managed one pound ingots which can be marked as to metal type and stored. These small ingots fit into all lead pots and furnaces without any problems.

6. The sizer/lubricator is, we feel, essential to the bullet caster reloading centerfire bullets. The Lyman #4500 not only sizes the cast bullet to the proper diameter, but also applies a gas check (if needed) and cleanly lubricates from its ample reservoir. Ours is a sturdy tool, designed for bench-mounting, which has proved itself over years of use. Thanks to the interchangeability of sizing dies and top punches the #4500 will handle just about any sizing situation producing clean, concentric cast bullets ready for loading.

Additionally, every caster should wear basic safety garb. We recommend that no casting be done unless the caster is protected by sturdy gloves and safety glasses. An accident with molten lead can have serious consequences.

Never allow moisture near molten lead. When moisture is introduced to molten lead, a terrific steam explosion occurs and molten metal is sprayed not only over the immediate area but also over the bullet caster. This moisture could be introduced by a wet ladle or dipper.

One last item for riflemen, essential to successful initial efforts, is the Lyman "M" Die which flares the case mouth just a bit. This makes seating the cast bullet undamaged that much easier. Lyman pistol die sets already include this type of expander.

Bullets can be cast and processed in the same area in which you reload. All primers and propellant should be cleaned up, containers sealed and put away.

There are no special fixtures needed...a folded towel will cushion the bullets as they fall from the mould. Surely there's an old box that will serve to catch sprue and rejects.

Venturing into bullet casting is really a rather simple task. Sure, there are plenty of variables with which to wrestle, but excellent results can be had right from the first by choosing good equipment and following the instructions for its use.

Casting Bullets (continued)

Melting and Fluxing Bullet Metal

When working with bullet metal, one of the first requirements is a suitable heat source capable of heating the metal to about 750° or 800° Fahrenheit. A simple cast iron pot to hold the metal and most any heat source (kitchen stove, etc.) will suffice. Improved equipment, such as the Lyman Electric Furnace, is more desirable. The electric furnace is cleaner, safer and more convenient. Its adjustable thermostat allows best control of the melt temperature. Whether you are blending the various metals into an alloy or actually casting bullets, the same melting and fluxing procedure is followed.

Heat the metal for about twenty minutes until it becomes a free-flowing liquid. It is then ready for fluxing.

To flux the metal merely drop a small bit of tallow, beeswax or bullet lubricant into the mixture. A smoky gas will rise from the top of the pot and should be immediately ignited with a match to eliminate the smoke.

A more modern-and much more pleasant- fluxing procedure is to use a dry substance, such as the product called MARVELUX. Smoke and greasy fumes are eliminated - an important benefit to those casters with wives and/or mothers in residence - and a good flux is obtained. This method is much preferable to the foregoing traditional technique.

Whichever flux substance you choose, be sure to stir the mixture with the dipper. As you stir, hold the dipper so the cup side is down and raise it out of the metal with each stirring stroke. This seems to help the flux.

Metal that has been properly fluxed will leave the surface almost mirror-bright and flecked with small particles of black and brown impurities. Skim off and discard these impurities. Flux the metal whenever, by its appearance, it seems to need it. While the dipper is not in use, it should be left in the molten metal to keep it hot.

Casting Bullets

After the metal has been fluxed and is hot enough to pour through the dipper, it is ready for casting. In addition to the mould, you should have on hand a hardwood stick (about 10" long) to be used for opening the mould. Also, pad a small area of your bench with an old piece of cloth or carpet. This will soften the fall of the hot bullets as they drop from the mould and prevent them from being damaged.

While there is no one set way to dipper-cast good bullets, we do offer the following as a suggested method. Fill the dipper with metal and place the spout of the dipper against the pouring hole in the mould's sprue plate. Holding the mould and dipper together, slowly turn them to a vertical position with the dipper above the mould.

Casting via the bottom pour valve on your electric furnace may require a slightly different technique. Instead of holding the mould tight against the external bottom pour valve and lifting the operating lever to release molten lead, it is often better to leave a little space between the mould and the bottom- pour valve - no more than an inch.

The latter method allows a good sprue puddle to form and, in some circumstances, may enhance the escape of air from the mould as the molten lead pours in.

If you find the lead is solidifying in the bottom pour valve, increase the pot temperature. Keep an ingot mould handy to catch drips.

The extra metal that runs over the top of the mould is called sprue. When it hardens, which

Casting Bullets (continued)

takes several seconds, pick up the hardwood stick and tap the sprue cutter sharply. This will separate the sprue from the base of the bullet. Drop the sprue into a cardboard box, or other receptacle. Open the mould and let the bullet fall to the pad. If the bullet does not drop out readily, use the stick to rap the hinge pivot of the mould handles sharply. Use only wood for this purpose and never strike the mould blocks themselves.

It is very important to pour a generous sprue and allow it to harden. As the bullet cools, it draws down metal from the molten sprue. If it cannot (i.e. the sprue has already hardened or is of insufficient size), then internal voids will form.

Further, cutting a still-molten sprue damages the bullet's base and often creates a buildup of smeared alloy between the cut-off plate and mould blocks.

As the mould will be cool, your first bullets will be imperfect. Casting bullets, one after the other, will bring the mould to the proper temperature. If you wish, the mould can be preheated by placing it on the rim of your furnace, or along side your lead pot on the stove. Never, under any circumstances, dunk the mould in the molten metal or subject it to direct flame.

Wrinkled bullets indicate that the mould, and/or metal, is too cool. Frosted bullets indicate that the mould, and/or metal, is too hot. Good bullets should be clean, sharp and fill the mould. Imperfect bullets should be collected and, along with the sprue, returned to the pot.

Bullets selected for accuracy shooting should be carefully weighed on the reloading scale. This reveals air pockets that may have formed in the bullet, lightening or unbalancing it. The actual weight of your bullets will depend pretty much on the composition of your bullet metal, which may vary slightly from lot to lot. Rejected bullets may be saved and recast.

Sizing and Lubrication

The sizing process is merely a method of swaging cast bullets to a diameter that corresponds to, or slightly exceeds, the groove diameter of your gun. Bullet sizing also ensures that the bearing bands of each and every bullet in the group are made perfectly round. As no metal is removed from the bullet (bullet is swaged to shape and size), sizing does not alter the bullet's as-cast weight.

Generally speaking, the less a bullet must be sized, the more accurately it will shoot. Some cast bullet shooters feel that .002" is the most a bullet can be sized and retain the ability to perform accurately.

Whether .002" is, indeed, the magic number is only part of the overall question. The real questions are the true dimensions of your gun. Rifles should be measured both at the muzzle and just past the chamber mouth. Handguns should receive the same bore measurements while revolvers should have each chamber mouth measured. The results of these tests should show you where to start.

To obtain these measurements you must drive a pure lead slug into the barrel or chamber mouth. Revolver owners should use a separate one for each chamber in a revolver's cylinder and identify them with the cylinder from which they came.

Normally, you define your initial "size to" diameter as one which will match, or slightly exceed, the groove diameter just ahead of the chamber. Sometimes revolver shooters have the matter confused by having a groove diameter larger than that of their chamber mouths. They should select their first sizing die on the basis of barrel, not chamber, dimensions.

Bullet casters should expect to experiment with several sizing diameters, just as they'll use

Casting Bullets (continued)

several types of propellant, in a given load development program. Normally, these other diameters will be greater than the groove diameter as discussed above. To shoot an under-sized cast bullet is to invite almost certain leading and inaccuracy.

Lyman plans the “as-cast” diameter of each caliber grouping to permit maximum utility within reasonable sizing ranges. We do not claim our moulds will cast to a single guaranteed diameter or that said cast bullets will be perfectly round. Instead, we state that we manufacture each of our moulds to cast a specified size in #2 Alloy with a manufacturing tolerance for both diameter variation and out-of-roundness. Each run of blocks is inspected at random both by dial indicator systems and actual casting and measurement of bullets.

The production of moulds to a customer’s specification is the domain of the custom mould maker - and even then there are few (if any) who will guarantee a perfectly round cast bullet from their mould. And, of course, the cost of such a custom mould is much greater than those produced for general consumption.

So the bullet which drops from a Lyman mould is intended to be reduced in diameter and trued up by the sizing process.

Sizing the cast bullet has been done a number of ways over the years. Today all sizing dies feature tapered leads which allows excess metal to be swaged, rather than shaved, into dimensional conformity.

During the recent Lyman review of specifications (which included the sizing dies as well), care was taken to maintain a satisfactory relationship between maximum as-cast diameter and minimum sizing diameter commonly used in a given caliber. Again, the standard bullet metal is #2 Alloy.

Lyman sizing dies, like the moulds, are made within certain size and manufacturing tolerances.

Lubricant, applied to the grooved body of a given bullet design, provides a film between the bullet metal and the walls of the bore. This film greatly reduces friction as the bullet travels down the barrel and either eliminates or minimizes leading.

It should also be noted that muzzle loading bullets should be cast in pure lead and shot “as-cast.” Lubricant is then applied by hand.

**Visit our complete Lyman website at
www.lymanproducts.com**

Predicted Physical Characteristics Of Bullets Cast In Various Lead Alloys

Caliber	Predicted As-Cast Characteristics										Predicted Dimensions—Sized			
	Bullet Example	Lead		Wheelweights		#2 Alloy		Linotype		H&I Sizing Die	Lead	Wheel Weights	#2 Alloy	Lino Type
		Wt. grs.	Dia.	Wt. grs.	Dia.	Wt. grs.	Dia.	Wt. grs.	Dia.					
Rifle														
.22	#225415	47	.2246"	46	.2246"	45	.2250"	44	.2252"	.224	.2237"	.2240"	.2240"	.2240"
.243, 6mm	#245496	87	.2437"	85	.2441"	83	.2445"	81	.2447"	.243	.2427"	.2430"	.2430"	.2430"
.25	#257420	68	.2576"	67	.2581"	65	.2585"	64	.2588"	.257	.2567"	.2570"	.2570"	.2570"
.270	#280642	157	.2776"	154	.2781"	150	.2785"	147	.2788"	.277	.2765"	.2770"	.2770"	.2773"
.280, 7mm	#287346	142	.2846"	139	.2850"	135	.2855"	133	.2858"	.284	.2836"	.2840"	.2840"	.2844"
.30	#311291	176	.3095"	173	.3100"	168	.3105"	163	.3108"	.308	.3076"	.3080"	.3080"	.3081"
8mm	#323470	167	.3234"	165	.3240"	160	.3245"	155	.3248"	.323	.3226"	.3230"	.3230"	.3233"
.35	#358315	215	.3578"	212	.3584"	206	.3590"	200	.3594"	.357	.3566"	.3570"	.3570"	.3573"
.375	#375449	276	.3773"	272	.3779"	264	.3785"	256	.3789"	.376	.3756"	.3760"	.3760"	.3763"
.45/70, 458	#457193	439	.4575"	433	.4583"	420	.4590"	407	.4595"	.457	.4566"	.4570"	.4570"	.4574"
Pistol														
.2.5	#252435	53	.2522"	53	.2526"	51	.2530"	49	.2533"	.251	.2507"	.2510"	.2510"	.2510"
.32	#311252	80	.3125"	79	.3130"	77	.3135"	75	.3138"	.309	.3086"	.3090"	.3090"	.3100"
9mm	#356242	96	.3558"	95	.3564"	92	.3570"	89	.3574"	.356	.3556"	.3560"	.3560"	.3563"
.38/357	#358156	156	.3578"	153	.3580"	149	.3590"	144	.3594"	.357	.3566"	.3570"	.3570"	.3573"
.41	#410610	225	.4101"	221	.4108"	215	.4115"	209	.4119"	.410	.4096.	.4100"	.4100"	.4103"
.44	#429421	256	.4296"	252	.4303"	245	.4310"	238	.4314"	.429	.4286"	.4290"	.4290"	.4294"
.45	#452374	235	.4515"	232	.4523"	225	.4530"	218	.4535"	.451	.4506"	.4510"	.4510"	.4514"